

Day 1

Practice reading this week's Sight Words.

like and
 cat dog
 to

****SPELLING TEST ON FRIDAY****

Practice writing the letter Tt

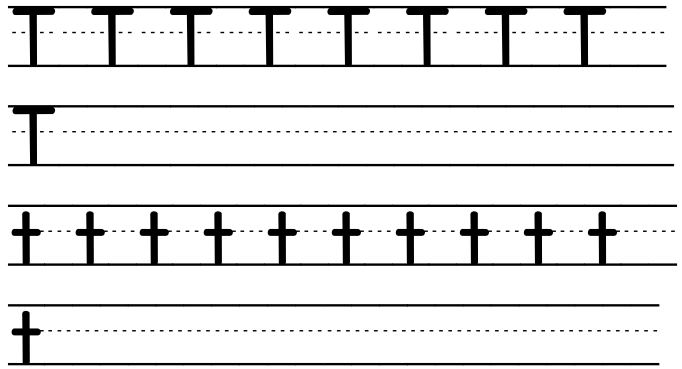

Practice reading this week's Sentences.

1. I like to play.
2. A cat and a dog can run.
3. A dog can run.
4. A cat likes to run and play.
5. We can run and play.

** Read or listen to reading for 20 minutes**

Circle the pictures that begin with Tt



Practice writing the numbers 5 & 6.

5 5 5 5 5 5 5 5 5 5

5

6 6 6 6 6 6 6 6 6 6

6

Trace the hexagons.

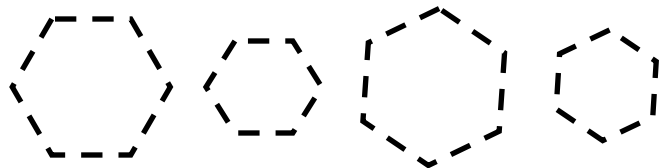

A Hexagon has _____ sides.

A Hexagon has _____ angles.

Color Of the Day: **green**

Color the objects

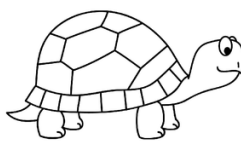
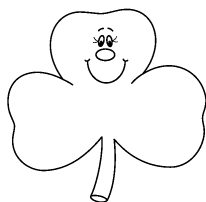
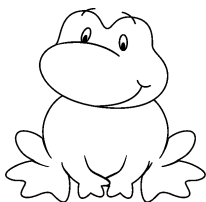
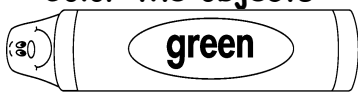

Hundreds Chart

1	2	3	4	5	6	7	8	9	10
11	12	13	14	15	16	17	18	19	20
21	22	23	24	25	26	27	28	29	30
31	32	33	34	35	36	37	38	39	40
41	42	43	44	45	46	47	48	49	50
51	52	53	54	55	56	57	58	59	60
61	62	63	64	65	66	67	68	69	70
71	72	73	74	75	76	77	78	79	80
81	82	83	84	85	86	87	88	89	90
91	92	93	94	95	96	97	98	99	100

Practice counting to 15.

Day 2

Match the Sight Words.

Like	dog
And	to
Cat	like
Dog	cat
To	and

****SPELLING TEST ON FRIDAY****

Circle the letter Tt

Q I C T I D n q w A g W O G I p R t Y i
 v t B h L M Z k I s o z r t a m q A U F
 V c D x R J l e T G E m H Q h Z E n H
 S X T c S F j Y v f N U t s D T d k t i
 f w J P T I W u O T K V y P t L y B i u
 C o t b t p i N S X e I z y T u N M e r
 x i P z L W h n i f S J T d L q w i X P G
 t I c R j f d m T v Q p a i y x k l N I w

Practice reading this week's Sentences.

1. A cat likes to run and play.
2. A dog can run.
3. We can run and play.
4. I like to play.
5. A cat and a dog can run.

**** Read or listen to reading for 20 minutes****

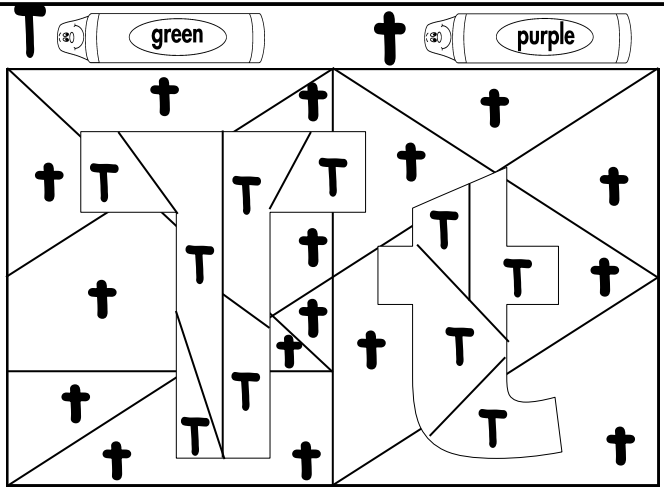

Count and label how many shapes.

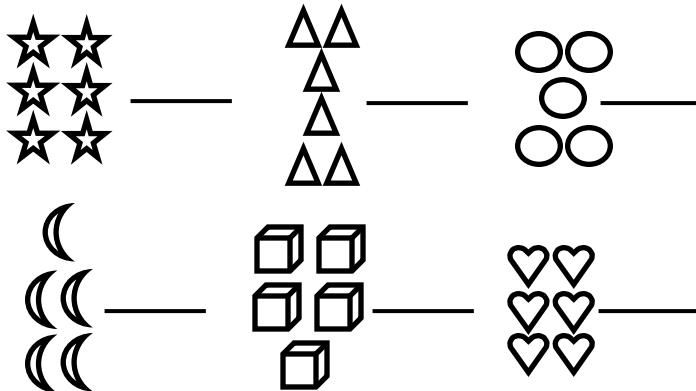

Count the Shapes:

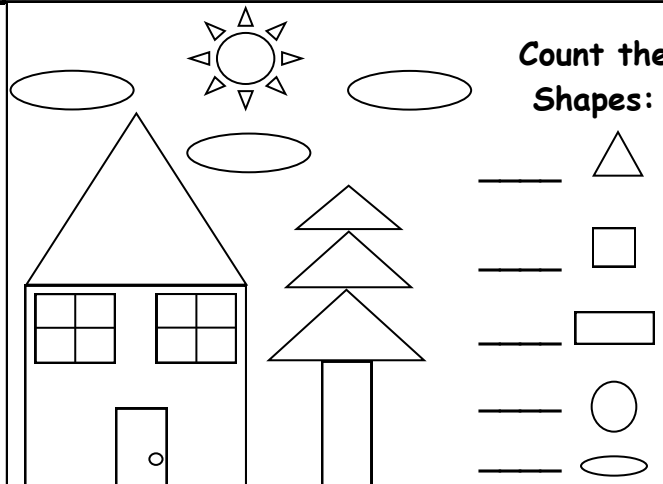

Color Of the Day: purple

Color the objects

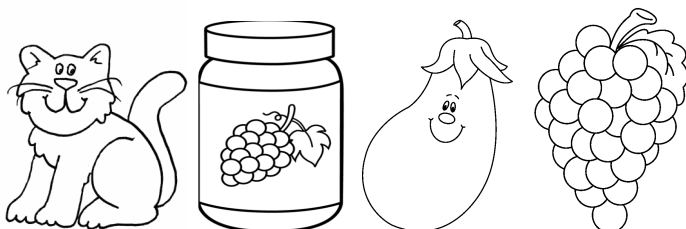
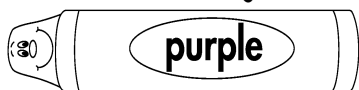

Practice writing numbers 1-15

1, 2, 3, 4, 5,
 6, 7, 8, 9, 10
 11, 12, 13, 14, 15

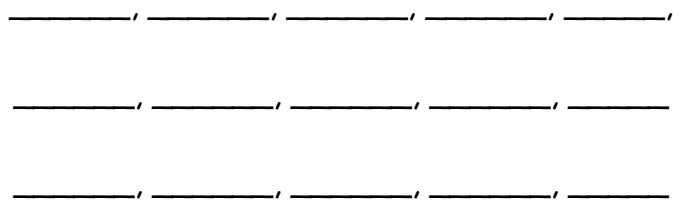

Day 3

Place the words in word boxes.

like, and, cat, dog, to

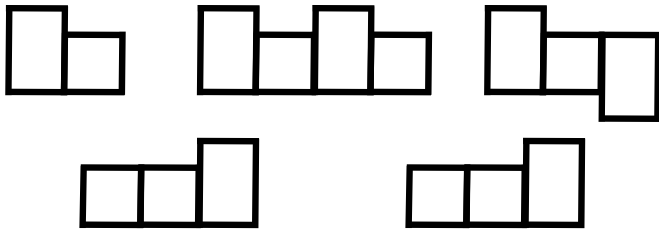

****SPELLING TEST ON FRIDAY****

Practice writing the letter Ii

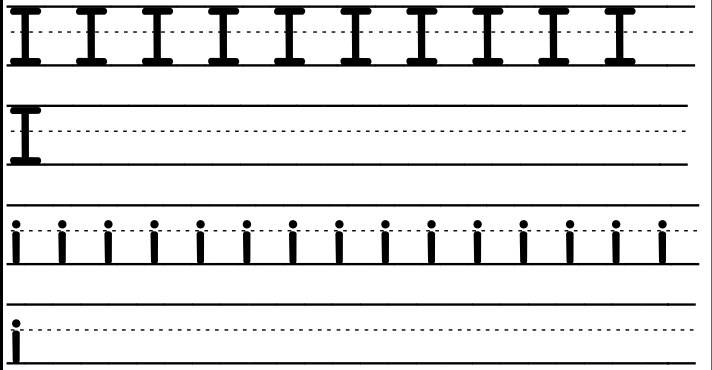

Fill-in the blanks using your sight words.

like, and, cat, dog, to

1. A cat likes _____ run and play.
2. A _____ can run.
3. We can run _____ play.
4. I _____ to play.
5. A _____ and a dog can run.

** Read or listen to reading for 20 minutes**

Circle the pictures that begin with Ii

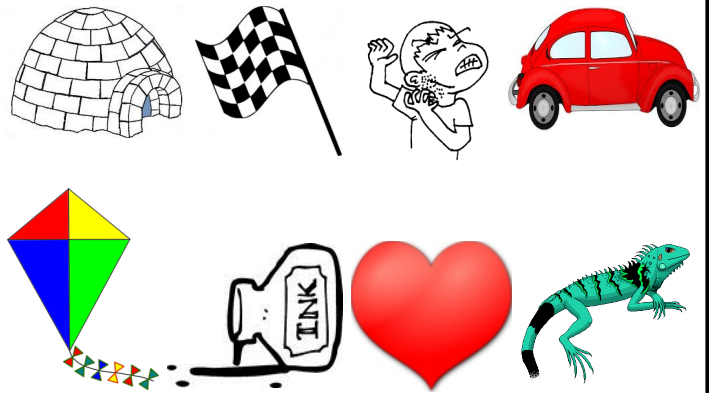

Practice writing the numbers 7 & 8.

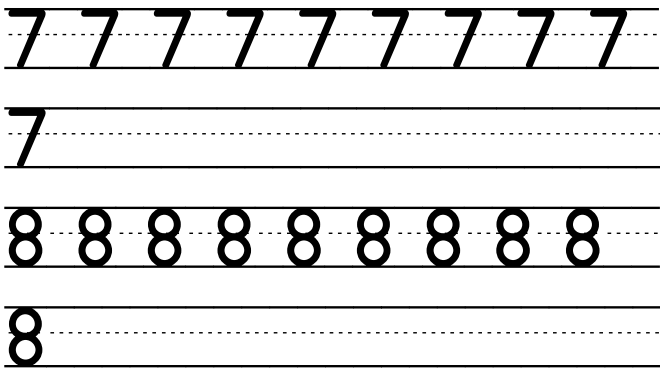

Trace the cubes.

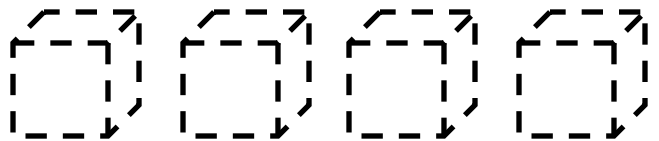

A Cube has _____ faces.

A cube is the shape of a _____.

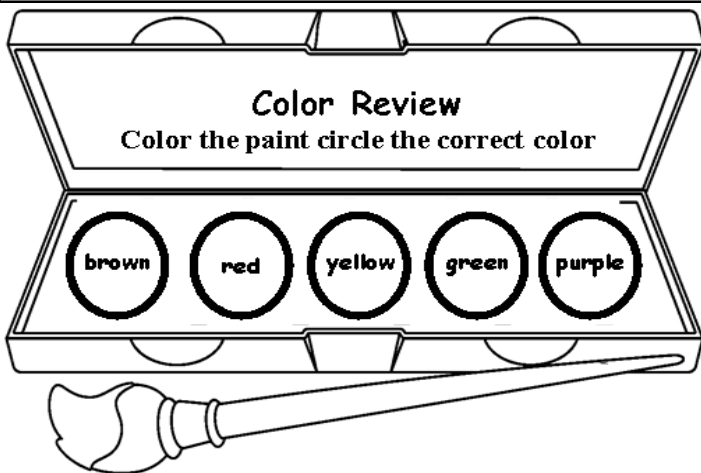

Fill in the missing numbers

- 1, 2, 3, 4, 5,
6, 7, 8, 9, 10
11, 12, 13, 14, 15
- 1, _____, 3, _____, 5,
_____, 7, _____, 9, _____
11, _____, 13, _____, 15

Write and read the sight words.

like

like

like



like

like

****Spelling
Test
Tomorrow****

Circle the letter Ii

Q I C T I D n q w A g W O G I p R t Y i
v t B h L M Z k I s o z r t a m q A U F
V c D x R J l e T G E m H Q h Z E n H
S X T c S F j Y v f N U t s D T d k t i
f w J P T I W u O T K V y P t L y B i u
C o t b t p i N S X e I z y T u N M e r
x i P z L W h n i f S J T d L q w i X P G
t I c R j f d m T v Q p a i y x k l N I w

I  i 

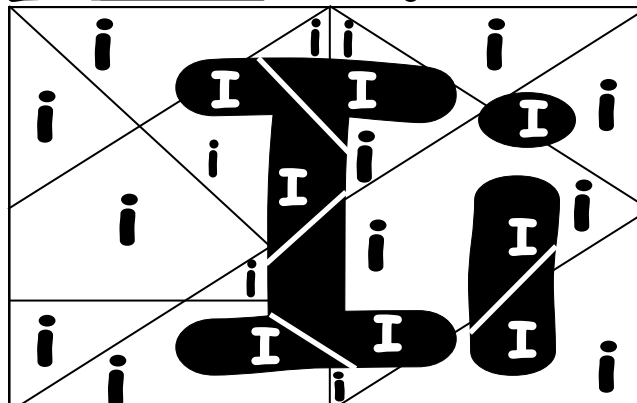

Write 3 sentences using your sight words.

1. _____
2. _____
3. _____

Count and label the number of shapes.

_____ _____ _____

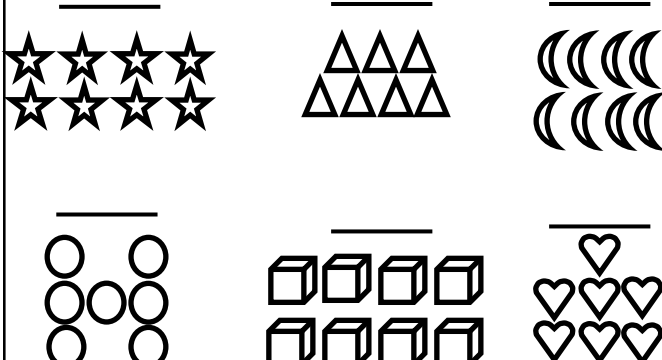

_____ _____ _____

Color Of the Day: **blue**

Color the objects

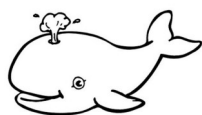
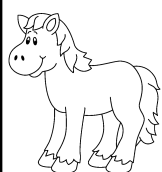

Fill in the missing numbers

1, 2, 3, 4, 5,
6, 7, 8, 9, 10

11, 12, 13, 14, 15

_____, 2, _____, 4, _____,

6, _____, 8, _____, 10,

_____, 12, _____, 14, _____